

UCSB for Modular Coil Spring Buffer Dimensions

Please contact us at Rubbershox.com/contact immediately if you have any questions about installing Modular Coil Spring Buffer on your vehicle. We are a US company located in Southern California.

(Do not Copy) UCSB is Patent Pending. This instruction is part of an installation manual that is under Copyright Protection by RubberShox®

WARNING: Customers require common automotive safety practices during the installations, we recommend installation be done by a professional mechanical knowledge. RubberShox® hold no liability for actual automotive safety practices.

DISCLAIMER: RubberShox® Bump Stop products DO NOT increase vehicle load capacity. They are designed to equalize loads support OE suspension for more stability and increase ground clearance. Please refer to your vehicle's owner's manual for maximum load capacity for safe operation.

Model	UCSB12344	UCSBH12344	UCSBM12344
Qty	2	2	2
Size	1/4 Circle	1/2 Circle	1/4 Circle
Shore A Hardness	Shore 70±5 HA	Shore 70±5 HA	Shore 80±5 HA
Supports vehicles up to	4000 Lbs / Pair	4000 Lbs / Pair	6000 Lbs / Pair
Material	Natural Rubber	Natural Rubber	Natural Rubber

(unit:inch)

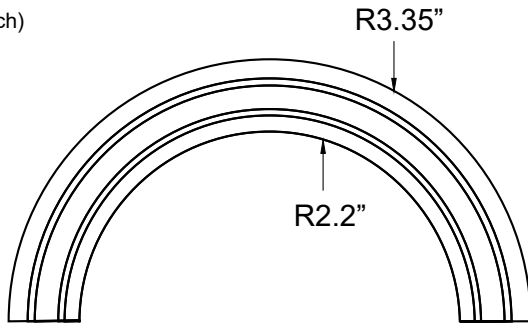

UCSBH12344

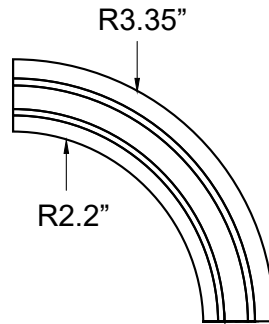

UCSB12344

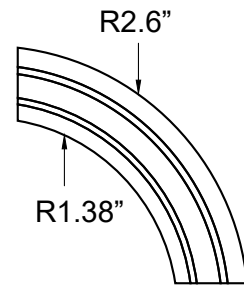

UCSBM12344

UCSB1/ UCSBH1/ UCSBM1

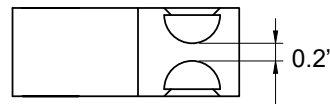

UCSB2/ UCSBH2/ UCSBM2

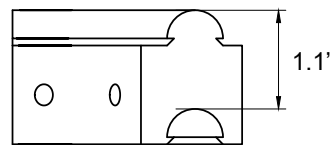

UCSB3/ UCSBH3/ UCSBM3

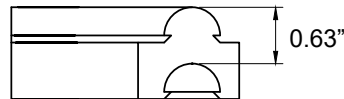

UCSB4/ UCSBH4/ UCSBM4

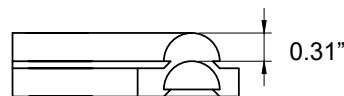

UCSB4/ UCSBH4/ UCSBM4

